

1. Part No. Expression:

L 2 – 4 7 N K - □□

(a) (b) (c) (d)

(a) Series Code

(c) Tolerance Code

(b) Inductance Code

(f) 10: Standard Code

2. Configuration & Dimensions :

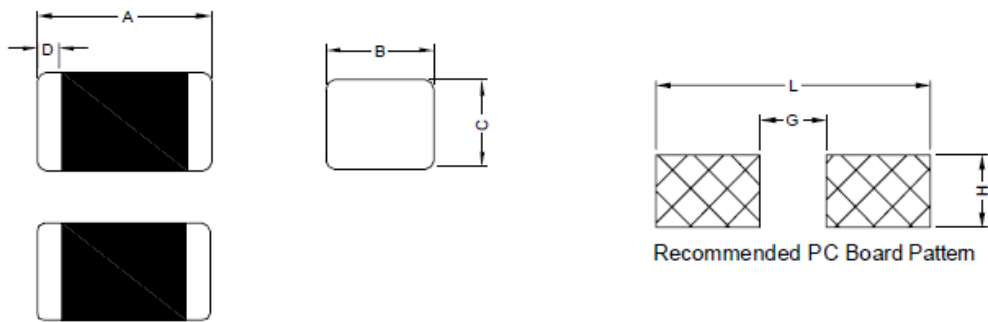

Unit: mm

A	B	C	D	G	H	L
1.60 ± 0.15	0.80 ± 0.15	0.80 ± 0.15	0.30 ± 0.20	0.85 Ref.	0.95 Ref.	2.45 Ref.

3. Schematic

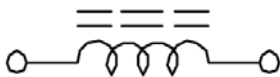

4. Material List

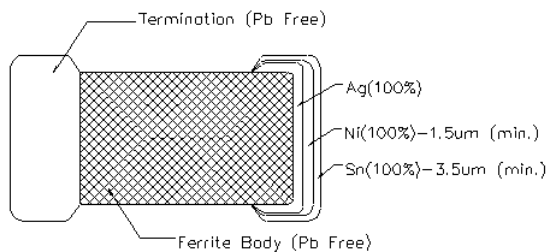

NOTE: Specifications subject to change without notice. Please check our website for latest information.

5. General Specification

- a) Operating Temperature: - 40°C to +105°C (including self-temperature rise)
- b) Storage Condition (component in its packaging)
 - i) Temperature: Less than 40°C
 - ii) Humidity: 60% RH

6. Electrical Characteristics

Part No.	Inductance (uH)		Q		Rated Current (mA) Max.	DCR (Ω) Max.	SRF (MHz) Min.
	Tolerance	Test Frequency (Hz)	Min.	Test Frequency (MHz)			
L2-47N□-10	0.047	60mV / 50M	10	50	50	0.30	260
L2-68N□-10	0.068	60mV / 50M	10	50	50	0.30	250
L2-82N□-10	0.082	60mV / 50M	10	50	50	0.30	245
L2-R10□-10	0.10	60mV / 25M	15	25	50	0.50	240
L2-R12□-10	0.12	60mV / 25M	15	25	50	0.50	205
L2-R15□-10	0.15	60mV / 25M	15	25	50	0.60	180
L2-R18□-10	0.18	60mV / 25M	15	25	50	0.60	165
L2-R22□-10	0.22	60mV / 25M	15	25	50	0.80	150
L2-R27□-10	0.27	60mV / 25M	15	25	50	0.80	136
L2-R33□-10	0.33	60mV / 25M	15	25	35	0.85	125
L2-R39□-10	0.39	60mV / 25M	15	25	35	1.00	110
L2-R47□-10	0.47	60mV / 25M	15	25	35	1.35	105
L2-R56□-10	0.56	60mV / 25M	15	25	35	1.55	95
L2-R68□-10	0.68	60mV / 25M	15	25	35	1.70	80
L2-R82□-10	0.82	60mV / 25M	15	25	35	2.10	75
L2-1R0□-10	1.0	60mV / 10M	30	10	25	0.60	70
L2-1R5□-10	1.5	60mV / 10M	30	10	25	0.80	55
L2-1R8□-10	1.8	60mV / 10M	30	10	25	0.95	50
L2-2R2□-10	2.2	60mV / 10M	30	10	15	1.15	45
L2-3R3□-10	3.3	60mV / 10M	30	10	15	1.55	38
L2-4R7□-10	4.7	60mV / 10M	30	10	15	2.10	33
L2-100□-10	10	60mV / 2M	30	2	15	2.55	17

Note: □ Tolerance: K=±10%, L=±15%, M=±20%

NOTE: Specifications subject to change without notice. Please check our website for latest information.



7. Characteristics Curves

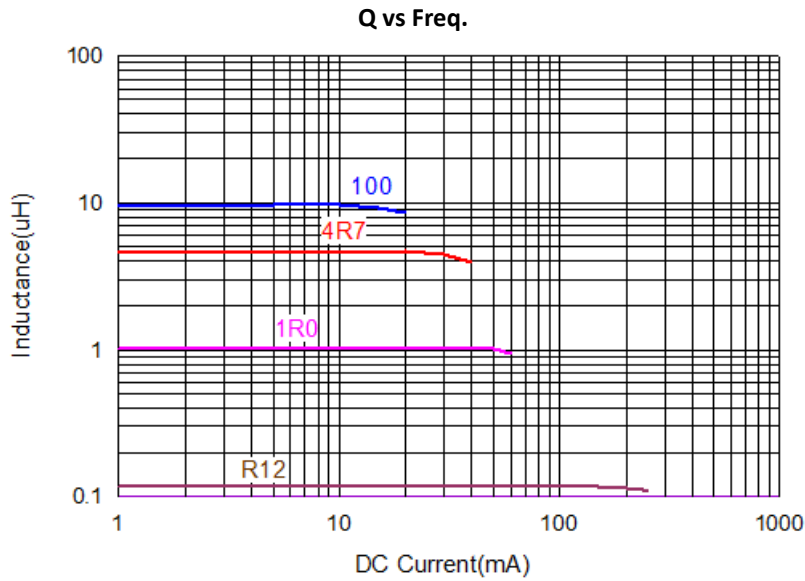
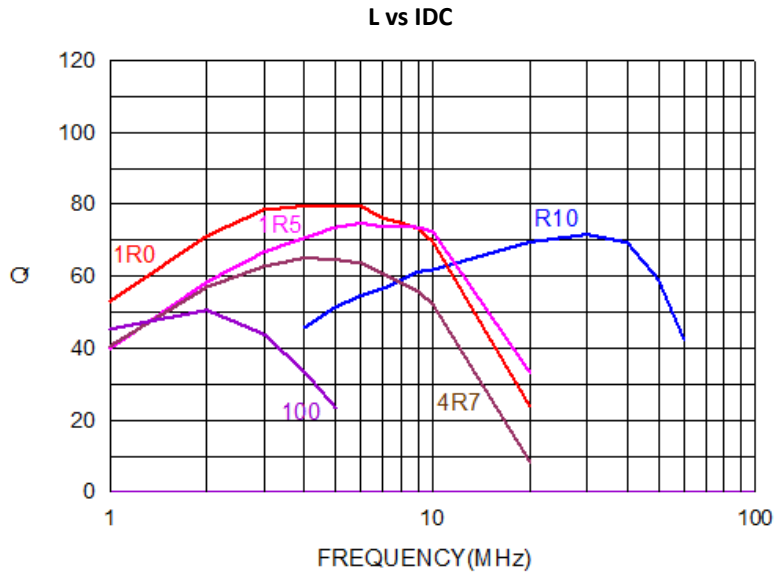

NOTE: Specifications subject to change without notice. Please check our website for latest information.



8. Soldering

Mildly activated rosin fluxes are preferred. The terminations are suitable for re-flow soldering systems. If hand soldering cannot be avoided, the preferred technique is the utilization of hot air soldering tools.

Note:

If wave soldering is used, there will be some risk.

Re-flow soldering temperatures below 240°C, there will be non-wetting risk

8-1 Solder Re-flow:

Recommended temperature profiles for lead free re-flow soldering in Figure 1.

8-2 Soldering Iron (Figure 2):

Products attachment with soldering iron is discouraged due to the inherent process control limitations. In the event that a soldering iron must be employed the following precautions are recommended.

Note:

- a) Preheat circuit and products to 150°C.
- b) 350°C tip temperature (Max.)
- c) Never contact the ceramic with the iron tip
- d) 1.0mm tip diameter (Max.)
- e) Use a 20 watt soldering iron with tip diameter of 1.0mm
- f) Limit soldering time to 4~5 secs.

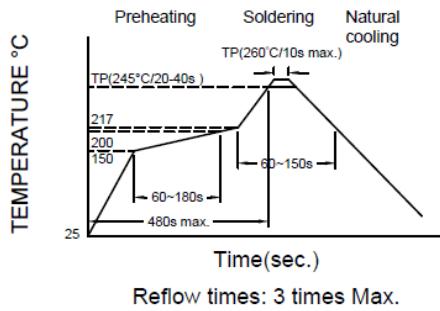

Fig.1

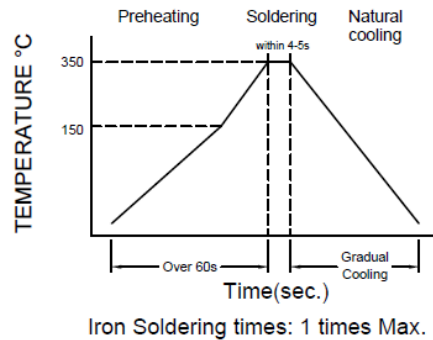

Fig.2

8-3 Soldering Volume:

Accordingly increasing the solder volume, the mechanical stress to product is also increased. Exceeding solder volume may cause the failure of mechanical or electrical performance. Solder shall be used not to be exceeding as shown in the Figure 3. Minimum fillet height = soldering thickness + 25% product height.

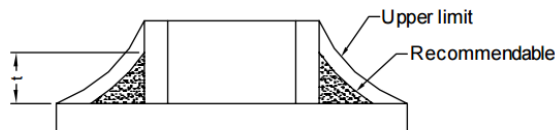

Figure 3

NOTE: Specifications subject to change without notice. Please check our website for latest information.



9. Packaging Information

9-1 Reel Dimension

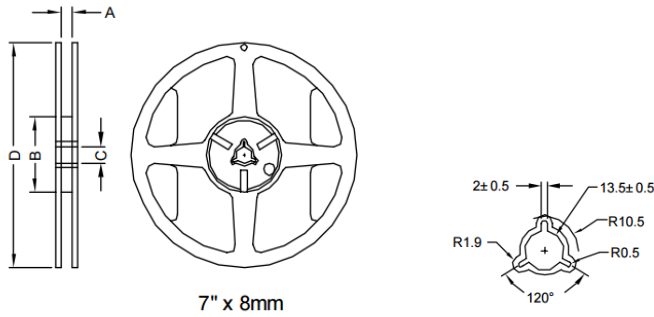

Type	A (mm)	B (mm)	C (mm)	D (mm)
7" x 8mm	9.0 ± 0.5	60.0 ± 2.0	13.5 ± 0.5	178.0 ± 2.0

9-2 Tape Dimension

Material of taping is paper

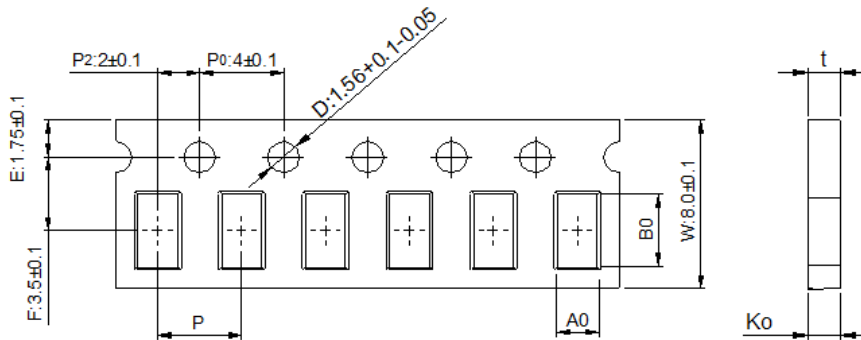

Size	Bo(mm)	Ao(mm)	Ko(mm)	P(mm)	t(mm)
160808	1.80 ± 0.05	0.96 ± 0.05 / -0.03	0.95 ± 0.05	4.0 ± 0.10	0.95 ± 0.05

NOTE: Specifications subject to change without notice. Please check our website for latest information.

9-3. Packaging Quantity

Size	160808
Chip/ Reel	4000
Inner Box	20000
Middle Box	100000
Carton	200000

9-4. Tearing Off Force

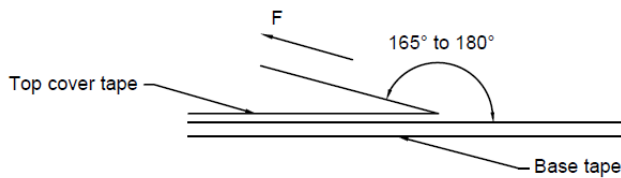

The force for tearing off cover tape is 15 to 60 grams in the arrow direction under the following conditions.

Room Temp (°C)	Room Humidity (%)	Room atm (hPa)	Tearing Speed (mm/min)
5 - 35	45 - 85	860 - 1060	300

Application Notice:

1. Storage Conditions:

To maintain the solderability of terminal electrodes:

- a) Recommended products should be used within 12 months from the time of delivery.
- b) The packaging material should be kept where no chlorine or sulfur exists in the air.

2. Transportation:

- a) Products should be handled with care to avoid damage or contamination from perspiration and skin oils.
- b) Vacuum pick up is strongly recommended for individual components.
- c) Bulk handling should ensure that abrasion and mechanical shock are minimized.

NOTE: Specifications subject to change without notice. Please check our website for latest information.

